

Optical Polarization Filters and Splitters Based on Multimode Interference Structures using Silicon Waveguides

¹Trung-Thanh Le, ²Manh-Cuong Nguyen

¹Faculty of Information Technology,
Hanoi University of Natural Resources and Environment, Hanoi, Vietnam
²Vietnam Pulmonary Hospital, Hanoi, Vietnam

ABSTRACT

In this paper, we would like to propose a novel design for realizing optical polarization filters and combiners based on multimode interference (MMI) structures using silicon waveguides. The device geometry is simple and eases of fabrication. In addition, analytical and numerical methods are used to optimize the designs for these devices in order to reduce losses and device size.

Keywords: *Integrated optics, polarization filters, polarization combiners, multimode interference (MMI) couplers, silicon waveguides*

1. INTRODUCTION

In recent years, silicon on insulator (SOI) technology has been used for the design and implementation of various integrated-optic devices. It is because the fabrication of such devices requires only small and low cost modifications to existing fabrication processes. SOI technology is compatible with existing complementary metal-oxide-semiconductor (CMOS) technologies for making compact, highly integrated and multifunction devices [1]. The SOI platform uses silicon both as the substrate and the guiding core material. The large index contrast between Si ($n_{Si}=3.45$ at wavelength 1550nm) and SiO_2 ($n_{SiO_2}=1.46$) allows light to be confined within submicron dimensions and single mode waveguides can have core cross-sections with dimensions of only few hundred nanometers and bend radii of a few micrometers with minimal losses.

Practical applications such as optical fibre communication systems usually require optical circuits that can handle arbitrary polarizations. One way of coping with signals having arbitrary polarizations is to use a polarization splitter to split the signal into Transverse Electric (TE) and Transverse Magnetic (TM) polarizations. The polarization of the TM signal can be rotated and then TE devices can be used on each polarization of the signal. After processing, the TM polarization can be restored and the signals recombined.

It is desirable to have compact polarization splitters and combiners that are suitable for photonic integration on the SOI platform. There have been some existing approaches

for creating optical wavelength filters [2-4] or optical polarization splitters and combiners [5, 6] on a variety of material systems. However, a suitable structure of optical polarization combiners or splitters using SOI waveguides has not been presented. The difficulty is due to the high index contrast of the SOI waveguide and high insertion losses. In this paper, we present new structures for designs of polarization filters and polarization splitters/combiners using MMI structures on an SOI platform. The aim of this paper is to optimize the designs in order to reduce the loss and to improve the performance of the devices. The advantages of these structures are low losses and ease of fabrication.

The paper is organized as follows: A description of the general theory behind the use of multimode structures to achieve optical polarization filters and splitters/combiners is presented in Section II. A brief summary of the results of this research is given in Section III.

2. GENERAL THEORY

2.1 Design of Optical Polarization Filters

The operation of optical MMI coupler is based on the self-imaging principle [7]. Self-imaging is a property of a multimode waveguide by which as an input field is reproduced in single or multiple images at periodic intervals along the propagation direction of the waveguide. The central structure of the MMI filter is formed by a waveguide designed to support a large number of modes. In the MMI section, the 2-D scalar Helmholtz wave equation is defined as

$$\frac{\partial^2 \psi}{\partial x^2} + \frac{\partial^2 \psi}{\partial y^2} + \left[\frac{2\pi n(x, y)}{\lambda} \right]^2 \psi = \beta^2 \psi \quad (1)$$

where $\psi(x, y, z) = \sum_{v=0}^{M-1} c_v \psi_v(x, y) \exp(j(\omega t - \beta_v z))$; x is the lateral dimension; y is the transverse dimension; z is the propagation direction; c_v is the field excitation coefficient; $\psi_v(x, y)$ is the modal field distribution; $n(x, y)$ is the refractive index profile, $v=0, 1, \dots, M-1$ are the mode numbers of the waveguide supporting M modes; λ is the optical wavelength and β is the propagation constant.

It was shown that MMI devices based on the symmetric interference theory can be used to form N -fold images at the outputs [8]. For a better understanding of this mechanism, a graphical demonstration of the formation of single (1x1 MMI) and double self-images (1x2 MMI) at the outputs at different MMI lengths is shown in Fig. 1. The input light beam (TE or TM) enters at the centre of the MMI structure. It is assumed that the MMI structure has a width of W_{MMI} .

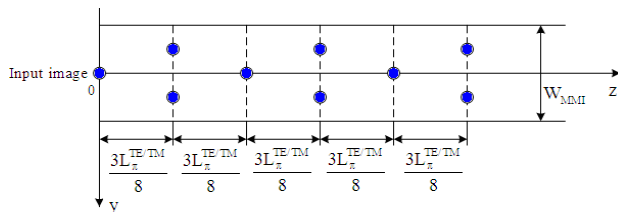

Fig. 1 Graphical demonstration for the formation of single and double images in an MMI structure

It can be seen from Fig. 1 that 1x1 MMI couplers can be formed at distances $z = 2p(3L_{\pi}^{TE/TM}/8)$ and that 1x2 MMI couplers are formed at distances $z = (2q+1)(3L_{\pi}^{TE/TM}/8)$, where p, q are integers and L_{π}^{TE} and L_{π}^{TM} are the beat lengths of the TE polarization and the TM polarization, respectively. It is quite easy to show that numbers p and q can be found that enable a 1x2 MMI coupler to be formed for the TE polarization and a 1x1 MMI coupler for the TM polarization, for the same overall MMI length.

Figure 2(a) shows the operating principle of polarization filters based on the interference mechanism. The length L_{MMI} of the MMI coupler must satisfy the equation:

$$L_{MMI} = 2p(3L_{\pi}^{TM}/8) = (2q+1)(3L_{\pi}^{TE}/8) \quad (1)$$

At this length, the TM polarized component exits the central output port while the TE polarized component is

suppressed at this port. In order to obtain the TE polarization, the length of the MMI coupler can be increased by $3L_{\pi}^{TE}/8$ to create the 1x1 MMI coupler for the TE polarization. High extinction ratios can be obtained if instead of increasing the length of the coupler, a second MMI coupler of length $3L_{\pi}^{TE}/8$ is connected as shown in Fig. 2(b).

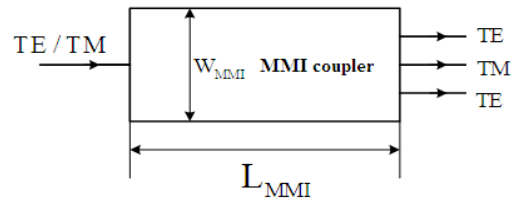

(a)

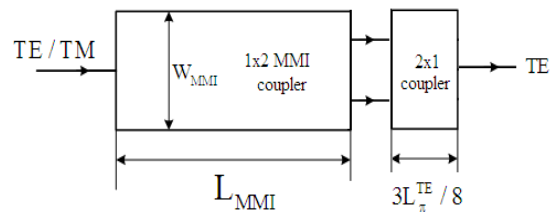

(b)

Fig. 2 Structure of MMI polarization mode filter (a) splitter (or TM mode filter) and (b) TE mode filter

Next, the detailed design for the TM and TE mode filters on the SOI platform shown in Fig. 3 will be carried out. The parameters used in the designs are as follows: the waveguide has a standard silicon thickness of $h_{co} = 220\text{nm}$ and access waveguide widths are $W_a = 0.48 \mu\text{m}$ for single mode operation. It is assumed that the central optical wavelength is $\lambda = 1550\text{nm}$. Here, SiO_2 ($n_{\text{SiO}_2} = 1.46$) is used as the upper cladding material.

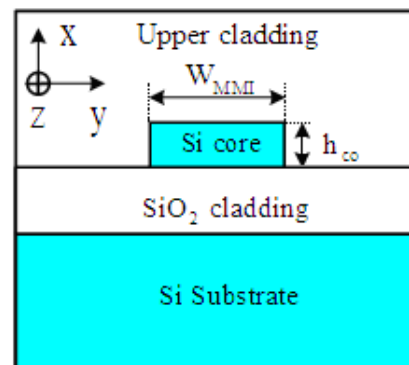

Fig. 3 Silicon waveguide cross-section used in the designs

It is well known that the finite-difference time-domain (FDTD) method is a general method to solve Maxwell's partial differential equations numerically in the time

domain. Simulation results for devices on the SOI channel waveguide using the 3D-FDTD method can achieve a very high accuracy. However, due to the limitation of computer resources and memory requirements, it is difficult to apply the 3D-FDTD method to the modelling of large devices on the SOI channel waveguide. Meanwhile, the 3D-BPM was shown to be a quite suitable method that has sufficient accuracy for simulating devices based on SOI channel waveguides [9, 10]. Therefore, the design for devices on the SOI platform will now be performed using the 3D-BPM.

It is also well-known that widening the access waveguides improves the performance of devices. It will be shown that they can be widened via a taper from a width of $W_a = 0.48\mu\text{m}$ to width $W_{tp} = 0.8\mu\text{m}$ [11].

Note that the MMI coupler in Fig. 2(a) is identical to the 1x2 MMI coupler in Fig. 2(b). It is assumed that the width of each MMI structure for both filters is $W_{\text{MMI}} = 3\mu\text{m}$. Such a width will allow a large separation between the access waveguides and thus little crosstalk. A waveguide thickness of 220nm and an access waveguide width of 500nm are used in the designs. The beat lengths of the MMI coupler for the TE and TM polarization calculated by using 3D-BPM are $L_{\pi}^{\text{TE}} = 23.5\mu\text{m}$ and $L_{\pi}^{\text{TM}} = 19.4\mu\text{m}$, respectively.

In order to design a TM mode filter, equation (1) is used. By substituting the beat lengths for the TE and TM modes into this formula, two integer numbers p , q and the MMI length can be found. In this case, $p=3$ and $q=2$ and the MMI length is $L_{\text{MMI}} = 43.5\mu\text{m}$. At this length, the TM polarization is presented at the output of the 1x1 MMI coupler while the TE polarization is filtered out at the output of the 1x1 MMI coupler. To find the optimised length of the MMI coupler, devices having a length of around this value are simulated by using the 3D-BPM method. The simulation results are shown in Fig. 4(a), in which a TM polarized beam is applied to the input. The optimised length is found to be $41.5\mu\text{m}$. At this optimised length, the excess loss for the TM filter (TM polarization output) is 0.13dB. Figure 4(b) shows the field evolution in the TM filter when excited by a TE input beam. The 3D-BPM simulation shows that the normalized power of this TE input beam at the output is 0.01 representing a loss of -20dB. The extinction ratio for the TM filter is therefore 19.8dB.

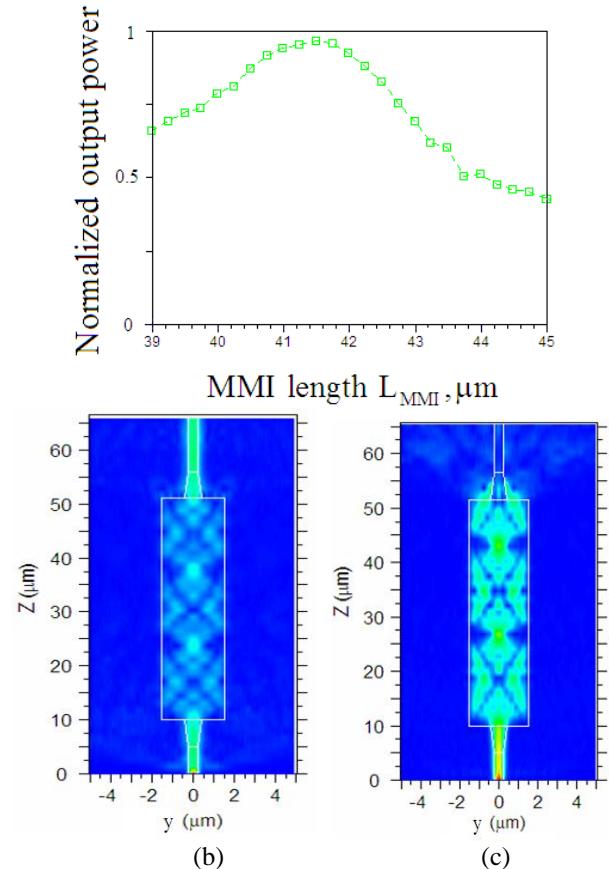

Fig. 4 Optimised designs for TE and TM mode filters (a) The normalized output powers of the TM mode filter at different lengths (b) 3D-BPM simulation for the device having an optimised length of $41.5\mu\text{m}$ and an input TM signal and (c) the 3D-BPM simulation for the device having an input TE polarization signal

The same MMI coupler can also be used as part of a TE mode filter. In order to produce the TE mode filter, a 2x1 MMI coupler with a length of $3L_{\pi}^{\text{TE}}/8$ is cascaded with the TM mode filter. The 3D-BPM is used to optimise the length of the device. The normalized output power as a function of length is plotted in Fig. 5(a). It can be seen that the optimised overall length is found to be $69.7\mu\text{m}$. Figure 5(b) shows the 3D-BPM simulation result of the device when a TE polarization signal is presented at the input port. The computed loss for the TE mode filter is 0.21dB. The simulation shows that the extinction ratio is 18dB for this device.

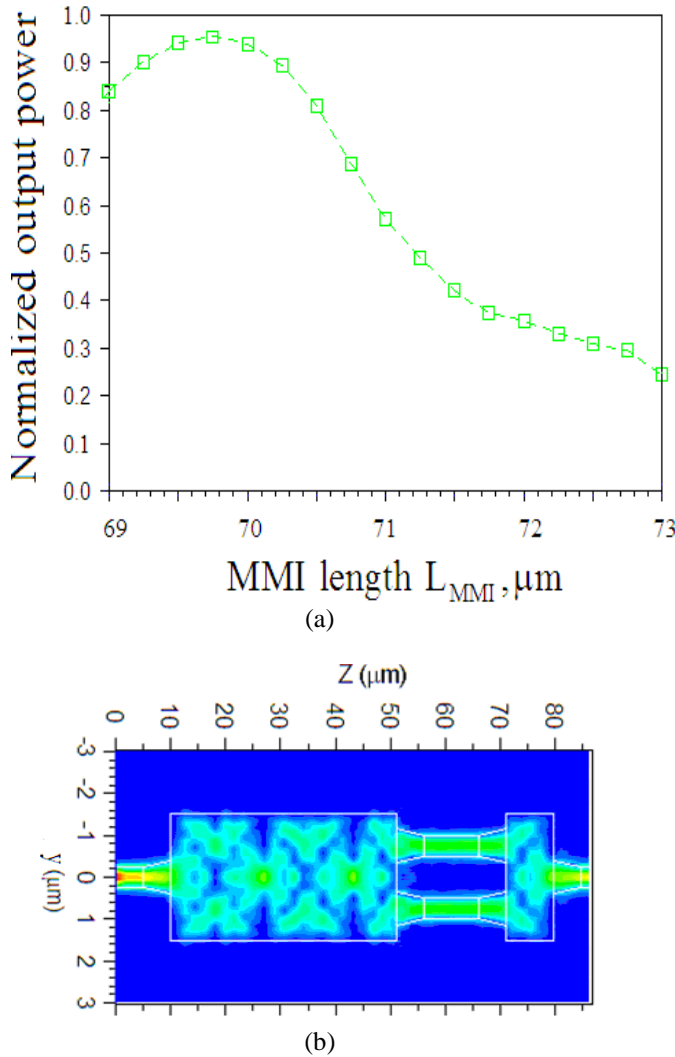

Fig. 5 (a) The normalized output powers of the TE mode filter at different lengths (b) the 3D-BPM simulation for the device having an optimised length of $69.7 \mu m$ and an input TE signal

2.2 Design of Optical Polarization Splitter/Combiner

Polarization splitters can be formed by using the 2x2 MMI structure shown in Fig. 6(b). The TE polarization signal exits one output port and the other is used for the TM polarization signal. Both RI and GI-MMI structures can be employed for this purpose. However, using the 2x2 RI-MMI structure enables the device to be more compact as shown in Fig. 6(a).

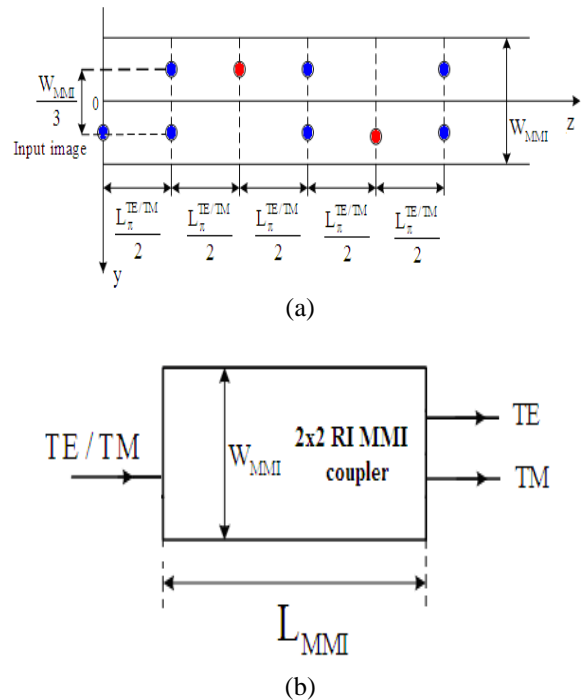

Fig. 6 Operating principle of the RI-MMI structure (a) graphical demonstration and (b) optical polarization splitter/combiner using a 2x2 RI-MMI coupler

The aim is to find a common MMI length so that at this length the bar port is used for the TE signal output and the cross port is used for the TM signal output. This means that the MMI length must satisfy the following relation

$$L_{MMI} = pL_{\pi}^{TE} = qL_{\pi}^{TM} \quad (3)$$

where p and q are integers.

We now investigate a polarization splitter using silicon waveguides. The MMI width is chosen to be $W_{MMI} = 4 \mu m$. The beat lengths for the TE and TM modes computed by the 3D-BPM method are $L_{\pi}^{TE} = 40 \mu m$ and $L_{\pi}^{TM} = 29.9 \mu m$, respectively. By substituting these values into equation (3), integer numbers p and q are found to be $p=3$ and $q=4$. The computed length of the MMI coupler is $L_{MMI} \approx 120 \mu m$. Using the 3D-BPM method to evaluate the device performance around this length leads to an optimised length of the MMI coupler of $L_{MMI} = 119.7 \mu m$. The BPM simulations for the TE and TM inputs at this optimised length are shown in Fig. 7(a) and 7(b), respectively. The computed excess losses for both cases are around 0.65dB and the extinction ratio is 22dB for splitting off the TE mode and is 20dB for splitting off the TM mode.

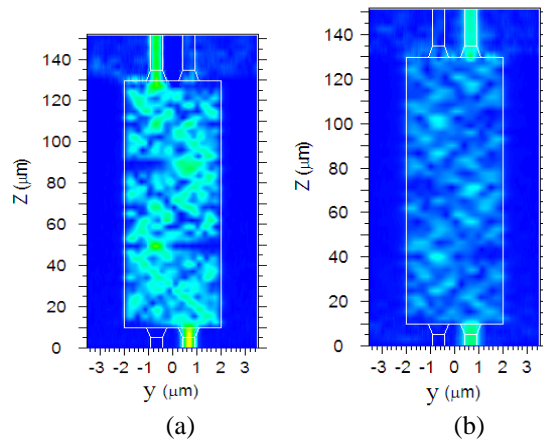

Fig. 7 The BPM simulations for the TE/TM splitter having the optimised length of 155 μm (a) TE polarization and (b) TM polarization

It is noted that polarization combiners can be created by swapping the input and output ports of the polarization splitters. The operating principle of the optical polarization splitters presented in this paper can also be used to design optical wavelength division multiplexers. In this case, the length of the MMI coupler is found by searching for the same length for different wavelengths instead of searching for the same length for different polarizations as used above analyses.

3. CONCLUSION

In summary, in this study we have presented a new method for designing optical polarization filters and combiners based on MMI structures on the SOI platform. The designs for these devices have been optimized by using the 3D-BPM method. The proposed devices are particularly important to optical integrated circuits operating in one polarization state.

REFERENCES

[1] L. Cahill and T. Le, "The design of signal processing devices employing SOI MMI couplers," presented at Paper 7220-2, Integrated optoelectronic devices (OPTO 2009), Photonics West, Proceedings of the SPIE, San Jose Convention Center, San Jose, California, USA, 24 - 29 January 2009.

- [2] M. Paiam and R. MacDonald, "Polarisation-insensitive 980/1550 nm wavelength (de)multiplexer using MMI couplers," *Electronics Letters*, vol. 33, pp. 1219 - 1220, 1997.
- [3] K. C. Lin and W. Y. Lee, "A dual-channel wavelength multiplexer / demultiplexer based on the restricted-resonance self-imaging effect," *Fiber and Integrated Optics*, vol. 16, pp. 73 - 81, 1997.
- [4] D. Mackie, T. Tayag, and T. Batchman, "Polarization separation/combination based on self-imaging," *Optical Engineering*, vol. 40, pp. 2265, 2001.
- [5] G. Kim, B. Kang, and S. L. e. al., "A multimode-interferenced electrooptic TE/TM mode splitter," presented at Proc.1999 CLEO/ Pacific Rim, Seoul, Korea, 30 Aug. -3 Sept. 1999.
- [6] L. B. Soldano, A. H. d. Vreede, and M. K. S. e. al., "Mach-Zehnder interferometer polarization splitter in InGaAsP/InP," *IEEE Photonics Technology Letters*, vol. 6, pp. 402-405, 1994.
- [7] M. Bachmann, P. A. Besse, and H. Melchior, "General self-imaging properties in $N \times N$ multimode interference couplers including phase relations," *Applied Optics*, vol. 33, pp. 3905-, 1994.
- [8] L. B. Soldano and E. C. M. Pennings, "Optical multimode interference devices based on self-imaging :principles and applications," *IEEE Journal of Lightwave Technology*, vol. 13, pp. 615-627, Apr 1995.
- [9] E. Dulkeith, F. Xia, and L. S. e. al., "Group index and group velocity dispersion in silicon-on-insulator photonic wires," *Optics Express*, vol. 14, pp. 3853-3863, 2006.
- [10] J. I. Dadap, N. C. Panoiu, and X. C. e. al., "Nonlinear-optical phase modification in dispersion-engineered Si photonic wires," *Optics Express*, vol. 16, pp. 1280-1299, 2008.
- [11] T. T. Le, L. W. Cahill, and D. Elton, "The Design of 2x2 SOI MMI couplers with arbitrary power coupling ratios," *Electronics Letters*, vol. 45, pp. 1118-1119, 2009.