



Design of Reversible Multiplier by Novel BHA Gate

Bhavani Prasad.Y, Rajeev Pankaj.N, Samhitha.N.R, Shruthi.U.K

School of Electronics Engineering, VIT University, Vellore -632014, TamilNadu, India

ABSTRACT

In this paper, a novel Reversible logic gate has been proposed and novel architecture for multiplier is constructed by using proposed gate and Peres gate. For Partial Product Generation BME Gate is used. This Multiplier gives better results when compared to previous circuits. This novel Gate can be used to design any Boolean logic expression and also any logic gate. The primary characteristics like garbage outputs, Constant inputs and number of gates got decreased. The logical calculations also got decreased. Power dissipation for Reversible logic gates is very less because of its reversibility property. So in present era, reversible logic gates can be used in many applications like bioinformatics, low power CMOS design, optical, quantum computing, DNA computing and also thermodynamic technology, Nanotechnology. The simulation was done in modelsim and synthesis was done by using rc compiler.

Index Terms—Reversible logic, Nanotechnology, Quantum computing

I. INTRODUCTION

In our present era decreasing power and increasing speed are two major concerns for any VLSI design. Normally in Irreversible gates there is no one to one mapping between the outputs and inputs and also power dissipation is also high and leakage of power is high. So we are going towards the new logic called the Reversible logic. According to R.Landauer, Irreversible gates can have more hardware complexity and high power dissipation because of information loss in the circuits[3,1]. In previous papers, information loss per bit can be given as $KT \ln 2$ joules at least per bit where K is Boltzmann constant and the value is $1.3806505 \times 10^{-23}$ (J/K) and T is given as the absolute Temperature in Kelvin's[1]. At room temperature the amount heat dissipated is very small but it is not negligible it is approximately 2.9×10^{-21} Joules. The heat obtained from single bit is small but according to moore, heat dissipation can increase in exponential fashion. The logic which does not have any information losses are called as the Reversible logic's. All computations which are considered to be quantum are necessarily to be a Reversible. All logic gates like AND, NOR, NAND, OR, EXOR etc are not Reversible except NOT gate.

Reversible logic gates has many applications in many research fields such as bioinformatics, low power CMOS design, optical, quantum computing, DNA computing and also thermodynamic technology, Nanotechnology. Multiplication is one of the fundamental block in almost all the arithmetic logic units.

In this Paper, totally five sections are there. Section I explains about complete introduction related to the Reversible logic gates and second section II describes about basics of Reversible logic gate and also all fundamental definitions related to it. Section III describes about complete list of logic gates present till now and also basic fundamental Reversible logic gates. Section IV describes about proposed Reversible logic gate and its expressions and truth table and explanation for its functioning as full adder and proposed N-bit adder circuits and also proposed multiplier circuit. Section V describes about results and comparison of proposed architecture with all previous architectures.

II. BASICS OF REVERSIBLE LOGIC GATES

There are many number of reversible logic gates such as NOT gate, CNOT gate, FEYNMAN gate etc All the reversible gates can have certain properties needed to be satisfied and all the definitions and properties related to reversible logic gates are discussed in below sections.

A. Basic Definitions:

A $K \times K$ Reversible logic gate can be represented as below

$$I_v = (I_1, I_2, I_3, I_4, I_5, \dots, I_k)$$

$$O_v = (O_1, O_2, O_3, O_4, O_5, \dots, O_k)$$

where O_v and I_v represents output and input vectors.

1. Reversible Function:

A Function $F(y_1, y_2, y_3, y_4, \dots, y_n)$ with n number of output variables is said to be a reversible function if it satisfies the following conditions are

- It has equal number of outputs and inputs.
- The pre-image of the output pattern should be unique one

i.e there should be one to one mapping between outputs and inputs[3,4,5].

2. Reversible logic gate:

A logic gate is said to be reversible if and only if

- The number of inputs and number of outputs are equal to each other.
- A one to one correspondence should present between inputs and outputs.

3. Constant inputs[12]:

These are one type of inputs which are unused in the design or to be kept as constant like 0 or 1 in the design so as to make it as Reversible. The total inputs are equal to the sum of the constant inputs plus primary inputs.

4. Garbage outputs[8]:

Garbage outputs are the extra outputs that are produced with in the design or the unused outputs are also called as the garbage outputs or in some cases the function can be a next function in order to make the function as reversible we can add some extra outputs are called as the Garbage outputs.

$$P.I + C.I = P.O + G.O.....(1)$$

Where

P.I represents primary inputs

- C.I represents constant inputs
- P.O represents primary outputs
- G.O represents garbage outputs.

5. Quantum cost:

Quantum cost is defined as the cost of design in terms of the cost of primitive gates. It can also be stated as the number of primitive reversible logic gates needed to produce the complete design. There are two primary primitive gates are 1x1, 2x2 both have the cost of zero and one respectively.

Some of the design constraints of Reversible logic gates are given as below [8,4]

1. The number of fanouts should be zero.
2. Quantum cost should be minimum.
3. Garbage outputs should be minimum.
4. Constant inputs should be minimum.
5. Minimum complexity or less number of logic gates.

III. REVERSIBLE LOGIC GATES

At present, so many reversible logic gates are there some of the logic gates are discussed in this section. The primary basic reversible gates are 1x1 and 2x2 which have the cost of zero and one respectively. Each gate has different values of Quantum costs and Quantum cost can be calculated by counting the number of V+,CNOT and V gates. V is obtained by calculating the square root of the NOT gate and V+ is obtained by the Hermitian of V. Some of the properties are given below

- V * V = NOT (1)
- V * V+ = V+ * V = 1 (2)
- V+ * V+ = NOT (3)

Some of the fundamental Reversible logic gates are given as below

1) NOT Gate:

This is fundamental gate among all Reversible logic gates and quantum cost of this gate is zero and it is a 1x1 reversible logic gate. The input and output vectors can be given as below

$$I_v = A \text{ and } O_v = (X=A')$$

The truth table is shown in table 1 and block diagram in fig 1 shown as below

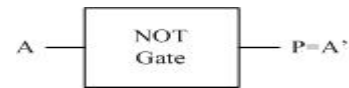

Figure 1. NOT Gate

Table 1. NOT Gate

A	P=A'
0	1
1	0

2) CNOT Gate:

This is also one of the fundamental gate and the cost is one and it is a 2x2 Reversible logic gate. The input vector and output vector are given as

$$I_v = (A,B) \text{ and } O_v = (X=A, Y=A^B)$$

The truth table is shown in table 2 and block diagram in fig 2 shown as below

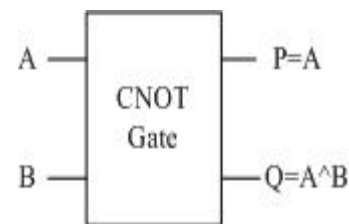

Figure 2. CNOT Gate

Table 2. CNOT Gate

A	B	P=A	Q=A^B
0	0	0	0
0	1	0	1
1	0	1	1
1	1	1	0

3) FEYNMAN Gate [6]:

It is also known as the copying gate or Controlled NOT gate(CNOT). It is a 2x2 Reversible logic gate and the Quantum cost is 1.

$$I_v = (A,B) \text{ and } O_v = (X=A, Y=A^B)$$

The truth table is shown in table 3 and block diagram in fig 3 shown as below

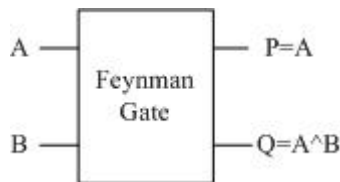

Figure 3. FEYMAN Gate

Table 3. FEYMAN Gate

A	B	P=A	Q=A^B
0	0	0	0
0	1	0	1
1	0	1	1
1	1	1	0

4) Double Feynman Gate (F2G):

It is also called as Double Feynman gate and it is 3x3 reversible gate. The input vector and output vector are given as

$$I_v = (A,B,C) \text{ and } O_v = (X=A, Y=A^B, Z=A^C)$$

The truth table is shown in table 4 and block diagram in fig4 as shown below

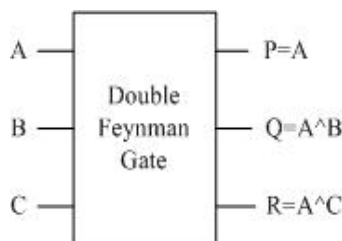

Figure 4. Double Feynman Gate

Table 4. Double Feynman Gate

A	B	C	P=A	Q=A^B	R=A^C
0	0	0	0	0	0
0	0	1	0	0	1
0	1	0	0	1	0
0	1	1	0	1	1
1	0	0	1	1	1
1	0	1	1	1	0
1	1	0	1	0	1
1	1	1	1	0	0

5) TOFFOLI Gate:

It is a 3x3Reversible logic gate and the Quantum cost is five. The input vector and output vector are given as

$$I_v = (A,B,C) \text{ and } O_v = (X=A, Y=B, Z=A.B^A C)$$

The truth table is shown in table 5 and block diagram in fig5 as shown below

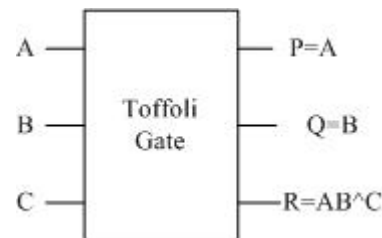

Figure 5. TOFFOLI Gate

Table 5. TOFFOLI Gate

A	B	C	P=A	Q=B	R=AB^A C
0	0	0	0	0	0
0	0	1	0	0	1
0	1	0	0	1	0
0	1	1	0	1	1
1	0	0	1	0	0
1	0	1	1	0	1
1	1	0	1	1	1
1	1	1	1	1	0

6) FREDKIN Gate[15]:

It is a 3x3Reversible logic gate and the Quantum cost is five. This gate can be used as a 2x1 Multiplexer. The input vector and output vector are given as

$$I_v = (A,B,C) \text{ and } O_v = (X=A, Y=A'.B+A.C, Z=A.B+A'.C)$$

The truth table is shown in table 6 and block diagram in fig 6 as shown below

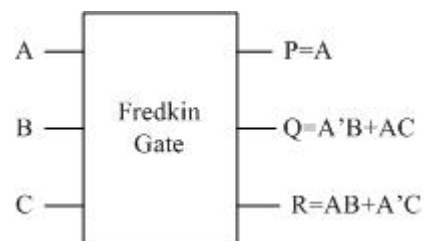

Figure 6. TOFFOLI Gate

Table 6. Fredkin Gate

A	B	C	P=A	Q=A'.B+AC	R=AB+A'.C
0	0	0	0	0	0
0	0	1	0	0	1
0	1	0	0	1	0
0	1	1	0	1	1
1	0	0	1	0	0
1	0	1	1	1	0
1	1	0	1	0	1
1	1	1	1	1	1

7) PERES Gate:(PG)[11]

It is a 3x3 Reversible logic gate and the Quantum cost is four. This gate can be used as a half adder circuit. The input vector and output vector are given as

$$I_v = (A, B, C) \text{ and } O_v = (X=A, Y=A \wedge B, Z=A \cdot B \wedge C)$$

The truth table is shown in table 7 and block diagram in fig 7 as shown below

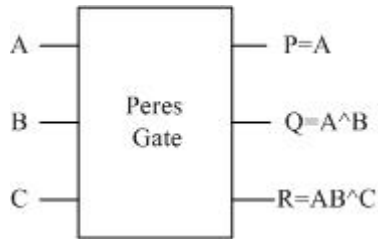

Figure 7. PERES Gate

Table 7. PERES Gate

A	B	C	P=A	Q=A^B	R=AB^C
0	0	0	0	0	0
0	0	1	0	0	1
0	1	0	0	1	0
0	1	1	0	1	1
1	0	0	1	1	0
1	0	1	1	1	1
1	1	0	1	0	1
1	1	1	1	0	0

7) BME Gate:[29]

It is a 4x4 Reversible logic gate and the quantum cost is five. This gate can be used for Partial Product Generation. The input vector and output vector are given as

$$I_v = (A, B, C, D) \text{ and } O_v = (P=A, Q=A \cdot B \wedge C, R=A \cdot D \wedge C, S=A' \cdot B \wedge C \wedge D)$$

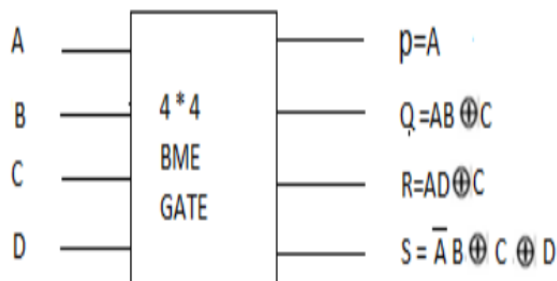

Figure 8: BME gate

The delay and cost of fundamental Reversible logic gates are given in table 8.

Table 8. Delay and cost

Type of gate	Worst case delay	cost
Controlled-V	1	1
Controlled-V+	1	1
Feynman	1	1
peres	4	4
toffoli	4	4
fredkin	5	5

IV. PROPOSED REVERSIBLE LOGIC GATE

In this section a new gate called BHA gate was explained and it is 4x4 gates and it can be used as a inverter, XNOR, Full Adder.

A) Proposed BHA Gate:

This is our new proposed 4x4 Reversible logic gate which can mainly function as a full adder circuit. The inputs and outputs to this gate are given below

$$I_v = (A, B, C, D) \text{ and } O_v = (P=A', Q=(A \wedge B)', R=(A \wedge B \wedge C), S=(A \wedge B) \wedge C \wedge (A \wedge B) \wedge D)$$

The truth table and block diagram of BHA gate as shown below

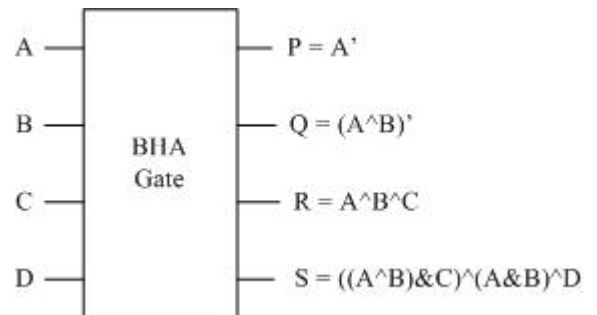

Figure 9. BHA gate

Table 9. Truth table for BHA gate

A	B	C	D	P	Q	R	S
0	0	0	0	1	1	0	0
0	0	0	1	1	1	0	1
0	0	1	0	1	1	1	0
0	0	1	1	1	1	1	1
0	1	0	0	1	0	1	0
0	1	0	1	1	0	1	1
0	1	1	0	1	0	0	1
0	1	1	1	1	0	0	0
1	0	0	0	0	1	1	0

1	0	0	1	0	1	1	1
1	0	1	0	0	1	0	1
1	0	1	1	0	1	0	0
1	1	0	0	0	0	0	1
1	1	0	1	0	0	0	0
1	1	1	0	0	0	1	1
1	1	1	1	0	0	1	0

The input and output vectors for BHA Gate to function as a full adder was

$$I_v = (A, B, C, 0) \text{ and } O_v = (P=A', Q=(A \wedge B)', R=\text{Sum}, S=\text{Cout}).$$

The above BHA gate can have 1 constant input and 2 Garbage outputs .

The input and output vectors for BHA Gate to function as a full adder was

$$I_v = (A, B, 0, 0) \text{ and } O_v = (P=A', Q=(A \wedge B)', R=\text{Sum}, S=\text{Cout}).$$

The above BHA gate can have 2 constant input and 2 Garbage outputs .

- Let us consider
- a= 2 input EXOR Gate
- b= 2 input AND Gate
- c= NOT gate
- T= Total Logical Calculations

From [5]: $T=6a+3b+3c$, for [16]: $T=5a+3b+3c$ and for this Proposed one $T=6a+2b+2c$ for each BHA gate. Hence the proposed full adder is better when compared to [5, 16].

B) ADDER Circuits:

Adders are the basic fundamental unit in any Arithmetic and logic unit. Ripple carry adders are the simplest architectures among all the types of adders. In ripple carry adder circuits carry is forwarded to the next stages and sum is generated at each stages.

1) Proposed Ripple Carry Adder circuit:

Let us consider a.b.c are the inputs to the gate and the sum can be given as the S_i and C_{i+1} . The intermediate carry can be forwarded o the next stages and at each stage the sum is generated and it is passed to the output stage. For each gate the number of garbage outputs are given as 2 and number of constant inputs are 1. Hence for a N-bit Ripple Carry Adder, generalized equation for Quantum cost can be given as $(2G+1C)*N$.

where N is the number of BHA gates used for N-bit adder.

The architecture for this ripple carry adder was given below.

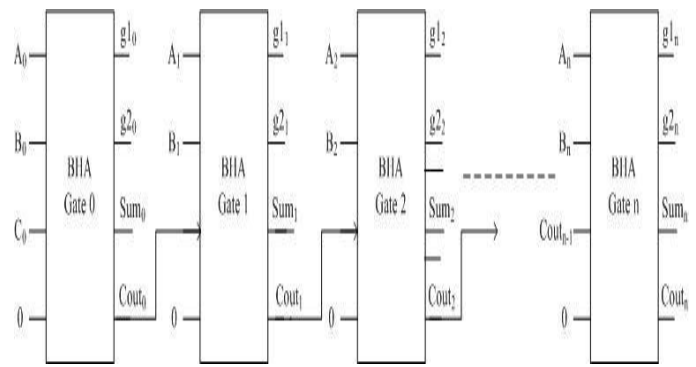

Figure 10. N-bit Ripple Carry Adder

C) Reversible Multiplier using BHA Gate:

In this section, a proposed architecture for 4x4 multiplier was shown in figure 12. To implement any multiplier we need adders and the adders for that multiplication has been produced by using BHA gate as mentioned above. Here for implementing a multiplier we have 2 steps are:

- 1) Partial Product generation
- 2) Addition of Partial products

Here in this paper Partial product generation can be done by using BME Gate because of its less Quantum cost and less complexity in hardware. Totally to implement a complete 4x4 multiplier we need 8 BHA, 8 BME Gates and 4 PERES gates. For Partial Product generation we need 8 BME Gates and for each PERES Gate has 2 Garbage outputs and 1 Constant input and for each BHA Gate has 1 Constant input and 2 Garbage outputs. For this proposed BHA gate has Total logical calculation of $T=88a+44b+24c$ and for [20] the Total logical calculation is: $T=110a+103b+71c$, and for [22] the logical calculation is: $T=80a+100b+68c$, for [21] the Total logical calculation is: $T=92a+52b+36c$. Hence proposed circuit is better than [20-22]. The multiplier partial products has shown in below figure 11

The Partial products can be generated by using BME Gate Is shown in below figure 11.

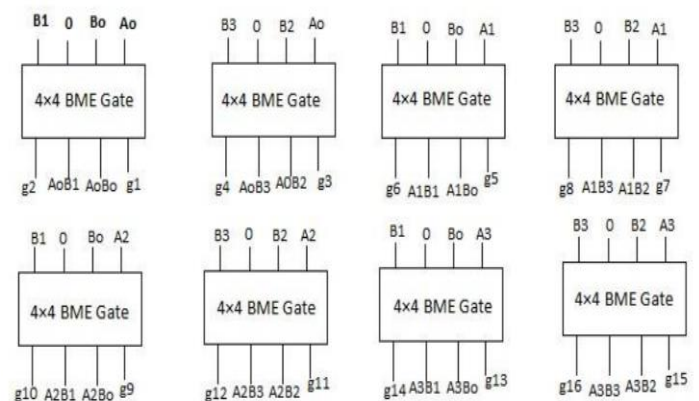

Figure 11: Partial Product Generation using BME Gate.

Table 10. Comparison of different Partial Product Generations

PARTIAL PRODUCT GENERATION	NO:OF GATES	NO:OF C.I	NO:OF G.O	QUANTUM COST(QC)
PROPOSED	8	8	16	40
PG[25]	28	40	32	88
MKG[2]	40	40	32	88
PFAG[12]	40	40	32	88
HNG[9]	40	40	32	88
TSG[4]	40	40	32	104

Table 11. Comparison of different Reversible multiplier results

REVERSIBLE MULTIPLIER	NO:OF GATES	NO:OF C.I	NO:OF G.O
PROPOSED MULTIPLIER	28	20	28
[27]	28	28	22
[24]	28	28	32
[23]	28	28	28
[22]	28	28	52
[21]	28	32	56
[20]	29	34	58
[19]	40	31	56
[25]	40	52	52
[2]	52	56	56
[12]	52	52	52
[9]	52	52	52
[4]	53	58	58

The Proposed architecture for 4x4 multiplier has shown in below Figure 12.

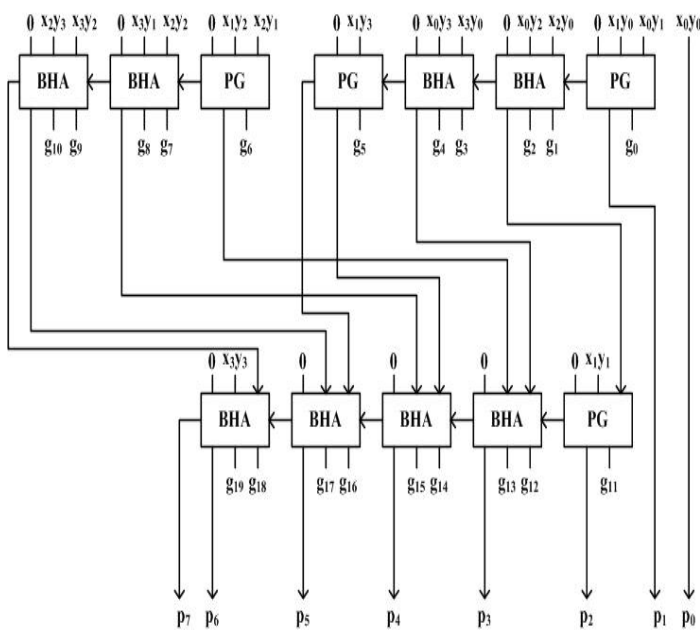

Figure 12. Proposed architecture for 4x4 Reversible multiplier using BHA and PERES Gate.

In the above architecture we have mainly used 8 Full adders and 4 Half adder circuits. The BHA Gate can be used as a Full adder circuit and PERES gate can be used as Half adder and also partial products generation. For Partial Product generation we use PERES Gate because of this one hardware complexity gets decreased when compared to the [20-27]. The comparison table of different Reversible multipliers has shown in below Table 11.

V. RESULTS AND DISCUSSION

In this paper mainly we have compared three parameters of reversible gates are the number of Reversible logic Gates, number of Garbage outputs, number of Constant inputs and also Total number of logic calculations. Here the Proposed circuit is better in all fields and give better results.

Garbage outputs are the outputs other than the primary outputs and in this paper its count is 52 far better than previous papers [20,21,22].

Constant inputs are also very less when compared with previous paper work [20,21,22]. Reversible gate count was slightly less than that of [21,22].

Total logical calculations are slightly got decreased i.e for this architecture it is $T=88a+36b+16c$. and for [20] it is $T=92a+52b+36c$ and for [21] it is $T=110a+103b+71c$ and for [22] it is $T=80a+100b+68c$.

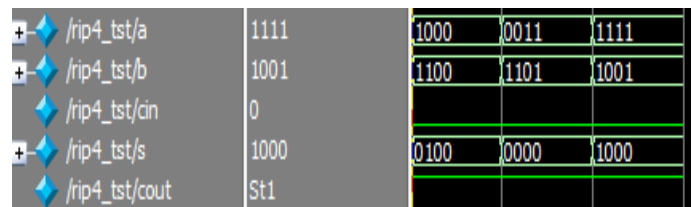

Figure 13. 4 bit adder using BHA gate

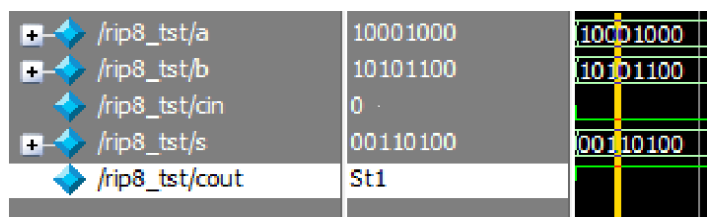

Figure 14. 8 bit adder using BHA gate

+ /rip16_tst/a	0001001000100000	0001001000100000
+ /rip16_tst/b	0010000000010010	0010000000010010
/rip16_tst/cin	0	
+ /rip16_tst/s	0011001000110010	0011001000110010
/rip16_tst/cout	St0	

Figure 15. 16 bit adder using BHA gate

+ /ut4_tst/a	14	10
+ /ut4_tst/b	9	12
+ /ut4_tst/q	126	120

Figure 16. 4 bit multiplier using BHA gate

/ut16_tst/a	4385	4641				4385
/ut16_tst/b	4899	4131				4899
/ut16_tst/q	21482115	19171971				21482115

Figure 17. 16 bit multiplier using BHA gate

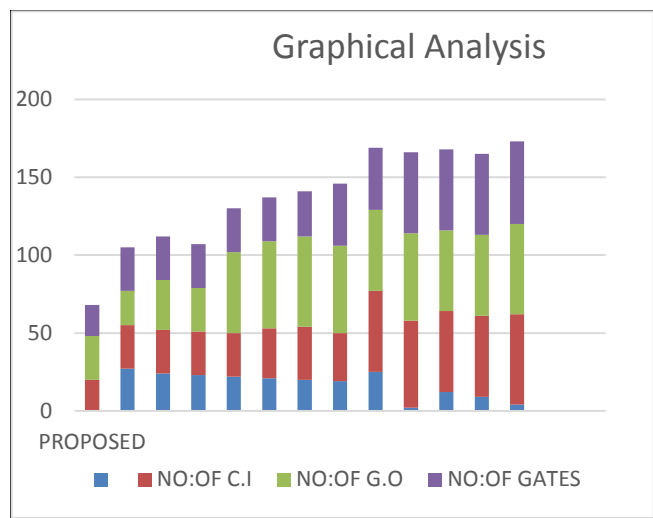

Figure 18. Graphical analysis of characteristics

VI. CONCLUSION

The proposed multiplier gives better results when compared to other multiplier techniques because the number of logic calculations gets reduced by using BHA Gate and PERES Gate. The comparison results shows that the Garbage outputs and constant inputs got decreased and the number logical calculations also got decreased by this proposed multiplier. The Proposed multiplier is very useful in many applications in bioinformatics, low power CMOS design, optical, quantum computing, DNA computing and also thermodynamic technology, Nanotechnology.

REFERENCES

- [1] Landauer, R., 1961. "Irreversibility and heat generation in the computing process", IBM J. Research and Development, 5(3) : 183-191.
- [2] C. H. Bennet, "Logical reversibility of computation", IBM J. Res. Develop., vol. 17, no. 6, pp. 525-532, 1973.
- [3] M. Perkowski, A. Al-Rabadi, P. Kerntopf, A. Buller, M. Chrzanowska-Jeske, A. Mishchenko, M. Azad Khan, A. Coppola, S. Yanushkevich, V. Shmerko and L. Jozwiak, "A general decomposition for reversible logic", Proc. RM 2001, Starkville, (2001) pp. 119-138.
- [4] Perkowski, M. and P. Kerntopf, 2001. "Reversible Logic. Invited tutorial", Proc. EURO-MICRO, Sept 2001, Warsaw, Poland.
- [5] Thapliyal Himanshu and M. B. Srinivas, 2005. "Novel reversible TSG gate and its application for designing reversible carry look ahead adder and other adder architectures." Proceedings of the 10 th Asia-Pacific Computer Systems Architecture Conference (ACSAC 05), Lecture Notes of Computer Science, 3740: 775-786.
- [6] Feynman, R., 1985. "Quantum mechanical computers", Optics News, 11: 11-20.
- [7] Toffoli T., 1980. "Reversible computing", TechMemo MIT/LCS/TM-151. MIT Lab for Computer Science.
- [8] Alan Mishchenko and Marek Perkowski, "Logic Synthesis of Reversible Wave Cascades", Portland
- [9] Quantum Logic Group, Department of Electrical and Computer Engineering, Portland State University, Portland, OR 97207, USA.
- [10] M. Haghparast and K. Navi, "A novel fault tolerant reversible gate for Nanotechnology based systems", Am. J. of App. Sci., vol. 5, no.5, pp. 519-523, 2008.
- [11] M. Haghparast and K. Navi, "Design of a novel fault tolerant reversible full adder for nanotechnology based systems", World App. Sci. J., vol. 3, no. 1, pp. 114-118, 2008.
- [12] Peres, A., 1985. "Reversible logic and quantum computers", Physical Review: A, 32(6): 3266-3276.
- [13] Saiful Islam, M.D. and M.D. Rafiqul Islam, 2005 "Minimization of reversible adder circuits". Asian J. Inform. Tech., 4 (12): 1146 1151.
- [14] Dmitri Maslov and Gerhard W. Dueck, "Garbage in Reversible Designs of Multiple Output Functions", University of New Brunswick, Fredericton, N.B. E3B 5 A3, CANADA.
- [15] Azad Khan, Md.M.H., 2002. "Design of full adder with reversible gate". International Conference on Computer

and Information Technology, Dhaka, Bangladesh, pp: 515-519.

- [16] E. Fredkin and T. Toffoli, "Conservative logic", Intl Journal of Theoretical Physics, pp. 219-253, 1982.
- [17] M. Haghparast and K. Navi, "A Novel Reversible Full Adder Circuit for Nanotechnology Based Systems", Journal of Applied Sciences, 7 (24) (2007) 3995-4000.
- [18] M. Haghparast and K. Navi, "A Novel Fault Tolerant Reversible Gate For Nanotechnology Based Systems", American Journal of Applied Sciences, 5 (5) (2008) 519-523.
- [19] M. Haghparast and K. Navi, "A Novel reversible BCD adder for nanotechnology based systems", American Journal of Applied Sciences, 5 (3) (2008) 282-288.
- [20] Thaplyal, H., M.B. Srinivas and H.R. Arabnia, 2005. "A Reversible Version of 4x4 Bit Array Multiplier With Minimum Gates and Garbage Outputs", The 2005 International Conference on Embedded System and Applications (ESA'05), Las Vegas, USA, pp: 106-114.
- [21] Thaplyal, H. and M.B. Srinivas, 2006. "Novel Reversible Multiplier Architecture Using Reversible TSG gate". IEEE international Conference on Computer Systems and Applications, pp: 100-103.
- [22] Shams, M., M. Haghparast and K. Navi, 2008. "Novel Reversible Multiplier Circuit in Nanotechnology". World Appl. Sci. J., 3 (5): 806-810.
- [23] Haghparast, M., Jafarali . S, Navi. K, Hashemipour. O, 2008, "Design of a Novel reversible Multiplier circuit using HNG gate in Nanotechnology", World Applied Sciences. J. , 3(6) : 974-978.
- [24] M. Haghparast , M. Mohammadi, K.Navi, M.Eshghi, "Optimized reversible multiplier circuit", Journal of Circuits, Systems, and Computers, World Scientific Publishing Company.
- [25] Nidhi Syal, Dr. H.P. Sinha, "High performance reversible parallel multiplier", International Journal of VLSI & Signal processing applications, Vol.1, Issue 3,(21-26), ISSN 2231-3133.

About Authors



Bhavani Prasad. Y Pursuing 2nd year M.Tech in VLSI Design in VIT University, Vellore, Tamilnadu, India. He has received his B.Tech degree in Electronics & Communications Engineering from Gudlavalleru Engineering College affiliated to JNTU-Kakinada, Andhra Pradesh, India in 2012.



Rajeev Pankaj N received his master's degree from IIT Guwahati in VLSI Design in 2009. Currently he is working as an assistant professor in Electronics department in VIT University, Vellore, Tamilnadu, India. His area of interests are Digital circuit designs, Quantum computing and FPGA Implementation.



Samhitha. N. R pursuing II year M.Tech in VLSI Design in VIT University, Vellore, TamilNadu, India. She has received her B.Tech degree in Electronics and Communication Engineering from Madanapalle Institute of Technology and Sciences affiliated to JNT University-Anantapur, Madanapalle, Andhra Pradesh, India in 2012.



Shruthi. U. K pursuing II year M.Tech in VLSI Design in VIT University, Vellore, TamilNadu, India. She has received her B.Tech degree in Electronics and Communication Engineering from T John Institute of Technology, Bangalore affiliated to Visvesvaraya Technological University, Karnataka, India in 2012.